

SIMULATION OF SOLAR THERMAL POWER PLANTS

Jayanta Kumar Nayak and Anish Modi

Department of Energy Science and Engineering, Indian Institute of Technology Bombay, Powai, Mumbai 400076, Maharashtra, India

Keywords: modeling, simulation, design, off-design, part-load, optimization, concentrating solar power, solar thermal energy

Contents

- 1. Introduction
 - 1.1. Design and OptimisOptimization
 - 1.2. Advantages and Limitations
- 2. Solar Thermal Power Plants
 - 2.1. Solar Field
 - 2.2. Thermal Energy Storage
- 3. Simulation Methods and Tools
 - 3.1. Types of Models
 - 3.2. Thermodynamic and Fluid Properties
 - 3.3. Performance Assessment and Design
 - 3.4. Model Verification and Validation
 - 3.5. Software
- 4. Conclusion
- Glossary
- Bibliography
- Biographical Sketches

Summary

This chapter presents the general details on modeling and simulation of solar thermal plants along with an example of a step-by-step process to design and optimize a central receiver solar thermal power plant with a steam Rankine cycle and a two-tank molten salt storage system. Section 1 explains modeling and simulation with simple examples and presents their advantages and limitations. Section 2 explains the configurations and working of typical solar thermal power plants. Section 3 presents the simulation methods with the design and the off-design modeling approaches and lists the commonly used software for simulating solar thermal power plants. Section 4 concludes the chapter and is followed by glossary, nomenclature, and bibliography.

1. Introduction

The term mathematical modeling refers to the process of representing a physical system or a process in terms of a set of mathematical equations, typically a combination of differential and algebraic equations. The term computer simulation refers to the process of solving the above set of equations using a computer software or a programming language. Modeling and simulation therefore allow us to analyze any physical system or process using computer tools. For any given system, a model is developed depending on

the purpose of the analysis or the assessment. The objective of any modeling exercise could be to determine the performance or the operational characteristics of the system through a simulation, given the knowledge of the system parameters. The system parameters include the physical dimensions, the thermodynamic state (e.g. temperature, pressure), and the fluid properties (e.g. thermal conductivity, viscosity). The results from the modeling and simulation exercises may be used for: (a) performance assessment on the basis of thermodynamic, economic, and environmental parameters, (b) comparison of alternate configurations, and (c) designing a new plant for some given conditions such as the plant location and the desired power output while optimizing the design configuration.

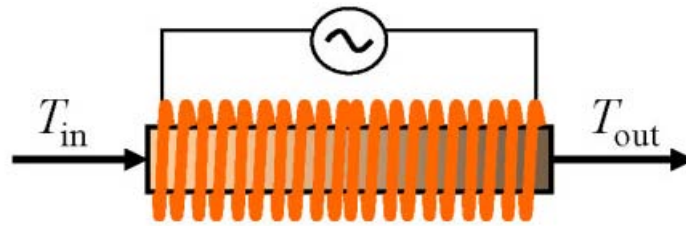

Figure 1. Flow of water inside an electrically heated pipe

We would consider a simple physical system to explain the concept of modeling and simulation. Figure 1 shows a simple system, consisting of water flowing inside a pipe while receiving heat from an electric wire wound around the pipe. The simplest way to model this system would be to write an energy balance for the system. Assuming no heat loss to the surroundings, the energy balance could be written as shown in Eq. (1).

$$\dot{W} = \dot{m}c_p (T_{in} - T_{out}). \quad (1)$$

The purpose of simulating this model could be to determine the outlet temperature (T_{out}) of the flowing water for known values of the supplied electrical power (\dot{W}), and the inlet temperature (T_{in}), the specific heat (c_p), and mass flow rate (\dot{m}) of the water. This could be done by rearranging and solving the Eq. (1) using a computer program.

1.1. Design and Optimization

While simulations involve determining the output from a model with given inputs and the system characteristics such as the physical dimensions and the thermodynamic properties, these can also be used for design and optimization purposes. Design is using the simulations to determine the system characteristics with given inputs and the desired outputs. Consider the following statement: Design a heat exchanger which transfers energy from a hot fluid with a given mass flow rate, temperature, and the allowable temperature drop to a cold fluid with a given mass flow rate, temperature, and a desired temperature rise. In this case, the system characteristics which could be considered a part of the design process would be (a) the type and configuration of the heat exchanger and (b) the physical specifications, most commonly specified by the heat exchanger area. Depending on the application, the configuration and the type of heat exchanger may be decided considering the research requirements or the industry practice. The type

of heat exchanger could be, for example, a tube-in-tube heat exchanger, a shell-and-tube heat exchanger, a plate heat exchanger, or any other type depending on the application and the operational characteristics such as the temperatures, the pressures, and the amount of the heat transferred.

Once it is fixed that we would like to design, say, a counter flow shell and tube type heat exchanger, we then proceed towards sizing it by determining the heat exchanger area. For this, we could use Eq. (2) which relates the heat transfer rate (\dot{Q}_{HX}) with the overall heat transfer coefficient (U), the area of the heat exchanger (A_{HX}), and the logarithmic mean temperature difference (ΔT_{lm}) over the heat exchanger. Here, the overall heat transfer coefficient may be estimated using the standard convective heat transfer correlations for the fluid flow on the shell side and the tube side, and including the heat conduction across the tube thickness. The heat transfer rate (\dot{Q}_{HX}) is obtained from the desired performance requirements from the heat exchanger.

$$\dot{Q}_{HX} = UA_{HX}\Delta T_{lm} . \quad (2)$$

For most of the design processes in an industrial setting, best practices are usually followed based on experience. However, if an entirely new design needs to be developed for an industrial application or research purposes, it may be relevant to optimize the design. In any optimization process, there are three key aspects: (a) the objective function, (b) the decision variables, and (c) the design constraints. The objective function defines the purpose of the optimization and could be a thermodynamic, economic, or a thermo-economic function which is either maximized or minimized. Examples of a maximization objective function are the power plant thermal efficiency, the net present value, and the annual energy generation. Examples of a minimizing objective function are the exergy destruction, the capital investment cost, and the levelized cost of electricity. The decision variables are those quantities which are varied during the optimization in order to identify that combination of the variables which satisfies the optimization objective. The design constraints are the limitations or restrictions imposed on the optimization process and may be represented using equality or inequality relations. These constraints include the bounds for the decision variables, i.e. the range of values within which the decision variables are changed during the optimization process. The constraints also include the values of the fixed input parameters which are the quantities that remain unchanged during the optimization.

1.2. Advantages and Limitations

Modeling and simulation are useful because of several reasons. They allow us to analyze a wide variety of systems without needing to perform that many experiments. This results in a huge cost saving potential, particularly for large and complex systems such as power plants where constructing a full-fledged power plant may not be a feasible option just to carry out experimental checks. In case where an experimental setup is planned to be developed, modeling and simulation may help in identifying the dominant parameters for the system before fabrication. This helps us effectively design the experiment and allocate more budget for buying more sensitive instruments for the

dominant parameters. An example for such a dominant parameter is the turbine inlet temperature for a power cycle. This parameter will have a more significant impact on the plant performance than say the pressure drop across the cycle. With modeling and simulation, it may also be possible to consider a much wider range of parameters for analysis than what would have been possible with the experimental setup. For example, if the experiment includes a refrigeration plant operating with a vapor compression cycle, it may be difficult to assess the performance using many different refrigerants in practice. It would however be straightforward to do so in a model by changing the various thermodynamic and fluid property functions in the computer program.

There are of course some limitations associated with modeling and simulation as well. The first is the necessity of simplification. It is difficult to include all the physical phenomena in the mathematical representation of any system. For example, for a power plant model on a system level, it may be difficult to include minor leakages, the variation in the insulation properties of the various pipelines, scaling in heat exchangers, failure of controllers, etc. This in theory results in a deviation of the model from the actual physical system. It is possible that such aspects do not impact the overall performance of the plant in a significant manner and may therefore be neglected. Another limitation is that the uncertainties of the various parameters based on practical operation are not always included during modeling and simulation. The uncertainties could also include the possible lack of complete knowledge about the physical system itself. Even when it is possible to represent a physical system or a process in its entirety using mathematical relations, it may still not be possible to solve these equations without simplifying them using certain assumptions. These assumptions may result in (a) errors associated with neglecting certain terms because of insignificance (e.g. radiation heat transfer in low temperature applications where other heat transfer mechanisms are dominant) and (b) errors associated with the assumptions used in the numerical schemes employed to solve the equations where analytical solutions are not possible (e.g. neglecting the higher order terms in a Taylor series expansion). In the model represented by Eq. (1), there are several assumptions that are inherently included, including some commonly used but often not mentioned. These include:

1. *Steady state operation*: There is no change in the system parameters with time.
2. *No heat loss*: There is no heat loss to the ambient and the only energy exchange which takes place is between the electric wire and the water flowing inside the pipe.
3. *No leakage*: There is no leakage of water anywhere in the pipe.
4. *No phase change*: The flowing water does not experience a change in phase during the entire heat transfer process, i.e. it stays in the liquid form during the process.
5. *Constant specific heat*: The specific heat value remains constant for water over the considered temperature range. In fact, the specific heat varies with the temperature and so this assumption may not be valid for a wide operational temperature range.

Thus, appropriate simplifying assumptions may be made depending on the modeled physical system and the purpose of the modeling exercise.

2. Solar Thermal Power Plants

A conventional thermal power plant converts the chemical energy of a fuel to electrical energy. The inputs to such plants are usually fossil fuels such as coal, oil, or natural gas. The chemical energy of the fuel is first converted into thermal energy by means of combustion. The thermal energy is then converted into electrical energy using a thermodynamic power cycle.

The most commonly employed power cycles in the large scale commercial power plants are (a) the steam Rankine cycle and (b) the combined cycle including a gas turbine and a steam Rankine cycle. Other power cycles such as the Kalina cycle (with ammonia water mixture as the working fluid), the supercritical carbon dioxide (sCO₂) cycle, and the organic Rankine cycle (with organic fluids or refrigerants as the cycle working fluid, mostly for low to medium temperature operation, say up to a turbine inlet temperature of around 300 °C) are also being assessed for use in solar thermal power plants. These are however at research and demonstration stages at present. Figure 2 shows the schematic of a simple steam Rankine power cycle with its key components. The cycle working fluid is water / steam. Heat is added externally to the boiler (BLR) by burning the fuel. This heat is used to convert high pressure and low temperature water (Stream 4) to high pressure and high temperature steam (Stream 1) in the boiler. This high pressure and high temperature steam is typically in a superheated state and it is expanded through a steam turbine (ST) to convert the thermal energy of the steam into the turbine shaft energy or mechanical energy. The turbine and the generator are connected by a shaft shown as a thick solid line in Figure 2. The shaft energy is then converted into electrical energy using a generator (GEN). The outlet of the turbine is a low pressure and low temperature mixture of water and steam (Stream 2). This mixture is then condensed to low pressure and low temperature water (Stream 3) by means of a condenser (CD) using an external cooling source such as a nearby natural water body. The low pressure and low temperature water is then pumped to the high pressure state (Stream 4) using a pump (PU) which closes the cycle.

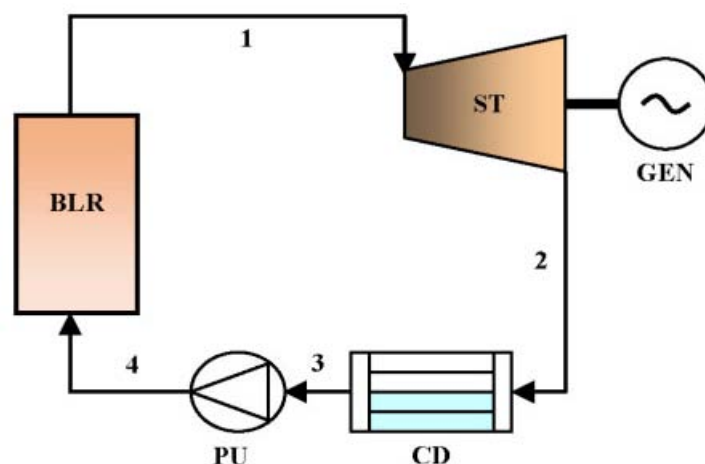

Figure 2. Schematic of a simple steam Rankine cycle (ST = steam turbine, GEN = generator, CD = condenser, PU = feedwater pump, BLR = boiler or steam generator)

Most current steam Rankine cycle power plants operate with a turbine inlet temperature and pressure of around 550 °C and 140 bar. These are sub-critical steam Rankine cycles, i.e. operating below the critical pressure for water (220.6 bar). Plants operating in the supercritical region for water are also being developed in order to achieve higher efficiencies. It may be noted that most commercially operating plants will have a significantly more complex cycle configuration including several feedwater heaters, several turbine stages (high pressure, intermediate pressure, and low pressure), and a reheater in addition to the boiler. Even if it is a more complex cycle configuration, the modeling approach and the mass and energy balances follow the same principle as explained for the simpler configuration.

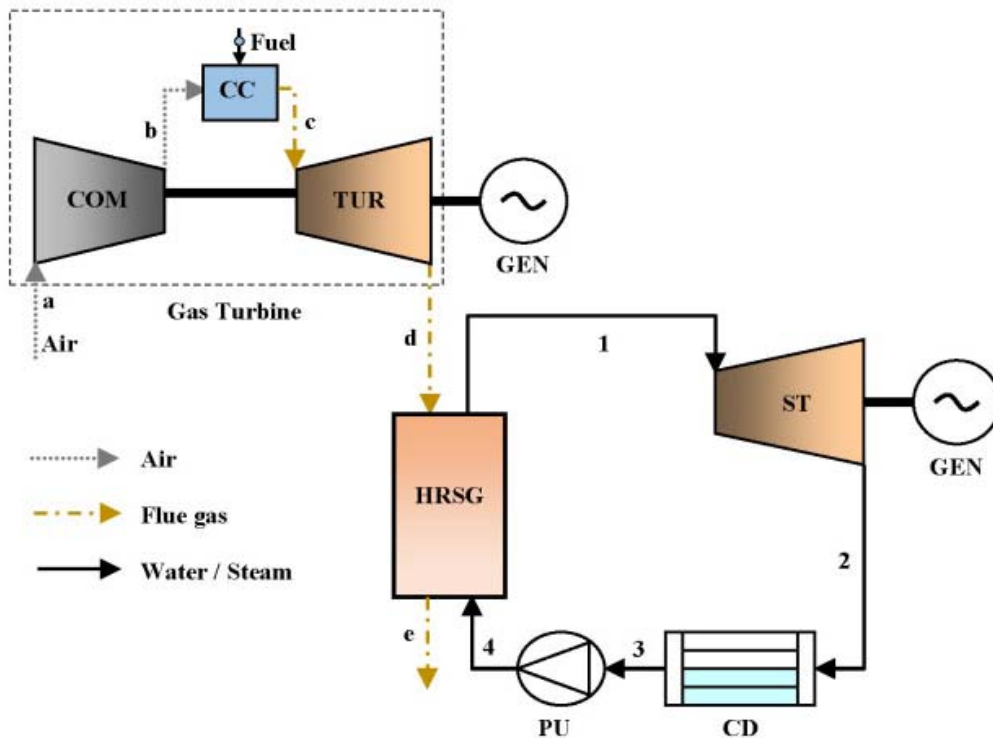

Figure 3. Schematic of a combined cycle power plant (COM = compressor, CC = combustion chamber, TUR = turbine / expander, ST = steam turbine, GEN = generator, CD = condenser, PU = feedwater pump, HRSG = heat recovery steam generator)

Figure 3 shows the block diagram of a typical combined cycle power plant operating with a combination of a gas turbine and a steam Rankine cycle for electricity generation. Ambient air (stream a) is compressed to a higher pressure (Stream b) using a compressor (COM) and is fed to the combustion chamber (CC). Fuel, usually natural gas, is also supplied to the combustion chamber where the fuel-air mixture is combusted to result in a high pressure and high temperature flue gas stream (Stream c). This flue gas expands in a turbine (TUR) to produce shaft work and exits the turbine (Stream d) at a much lower temperature than the entry temperature (Stream c). The compressor, the turbine, and the generator are all connected to the same shaft as shown by a thick solid line in Figure 3. The temperature of the flue gas exiting the turbine (Stream d) is still high, around 600 °C, and therefore a bottoming steam Rankine cycle is used to recover this energy before the flue gas is released to the ambient (Stream e). The bottoming

steam Rankine cycle includes a heat recovery steam generator (HRSG) which converts the high pressure and low temperature water (Stream 4) to high pressure and high temperature steam. The difference between using only a steam Rankine cycle and a bottoming steam Rankine cycle with a gas turbine is that the external heat in the bottoming cycle is supplied by the flue gas exiting from the gas turbine instead of the heat being supplied by burning a fuel like coal or oil. The rest of the operation is same as the steam Rankine cycle explained earlier.

In a solar thermal power plant, the principle of operation is broadly the same as a conventional thermal power plant. A key difference is that the external thermal energy input to the power cycle in a solar thermal power plant comes from focusing or concentrating the incident solar radiation instead of burning a fossil fuel. This concentration results in a much higher heat flux than the incident solar radiation, which in turn results in obtaining the high temperatures required for operating the power cycle. Because concentrated solar radiation is used as the 'fuel' in a solar thermal power plant, they are also referred to as concentrating solar power plants or CSP plants. As the solar radiation varies throughout the day (diurnal variation) and during the seasons (seasonal variation), it becomes necessary to include some form of thermal energy storage within the plant to improve the overall operation. Thus, the three key subsystems of a solar thermal power plant are the solar field, the thermal energy storage system, and the power block. These are shown in Figure 4. In the solar field, solar collectors concentrate the incident solar radiation on to suitable receiver(s) and convert it into thermal energy. A heat transfer fluid flowing through the receiver picks up a part of this energy and transfers it to the working fluid of the power cycle or the power block. At the same time, excess energy is transferred to the thermal energy storage system where it is stored for use during low sunshine hours or to extend the operation of the plant beyond the sunshine hours. Most of the earlier solar thermal power plants were designed and constructed without any thermal energy storage system, but nearly all the recent and the upcoming plants include at least some hours of storage.

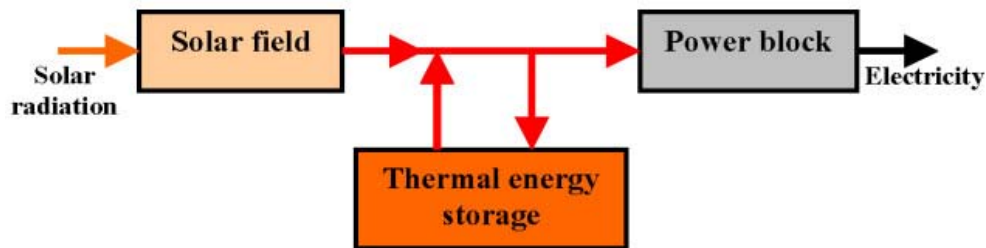

Figure 4. Flow of energy in a solar thermal power plant

2.1. Solar Field

The solar field consists of an array of concentrating collectors, connected in series and parallel combinations depending on the requirement. The collectors may be of reflecting type or refracting type. In the refracting type of solar field, there are lenses (e.g. Fresnel lenses) which focus the incident solar radiation on the focal point of the lens. These have recently been put into operation for district heating and domestic hot water applications. For the power generation applications, it is however more common to use the reflecting type of solar collectors. Such collectors include highly reflecting mirrors

focusing the incident sunlight on a line or a point where suitable receivers are placed. A heat transfer fluid flowing through the receiver picks up the heat which is then used to indirectly or directly drive a prime mover. The heat transfer fluid may be a mineral oil, a synthetic oil, or a molten salt. It may also be water / steam in case of the direct steam generation systems where water is converted into steam in the receiver itself.

In order that the sun's rays should always be focused at the receiver, the reflecting mirrors are required to be rotated. This movement is called tracking. There are two types of line focusing solar collectors (the parabolic trough and the linear Fresnel reflectors) and two types of point focusing solar collectors (the paraboloid dish and the central receiver). The solar radiation incident on the solar collector mainly consists of two components: (a) the direct or the beam radiation and (b) the diffused radiation. There may also be some reflected radiation from the ground or from the surrounding surfaces such as buildings, but it is generally negligible when compared with the direct and the diffused components. The direct or beam radiation is the radiation which comes directly from the sun without getting scattered, while the diffused radiation is that part of the solar radiation which gets scattered by the atmospheric components such as aerosols and clouds. The direct radiation component is what is mainly focused by the concentrating collectors. The factor by which the incident solar radiation is concentrated is defined by the concentration ratio for the solar collector system. It is common to use the geometric concentration ratio for most practical calculations. It is defined as the ratio of the concentrator aperture area to the receiver area. The aperture area may or may not be the same as the reflector surface area, and is defined as the plane opening of the concentrator through which the solar radiation passes.

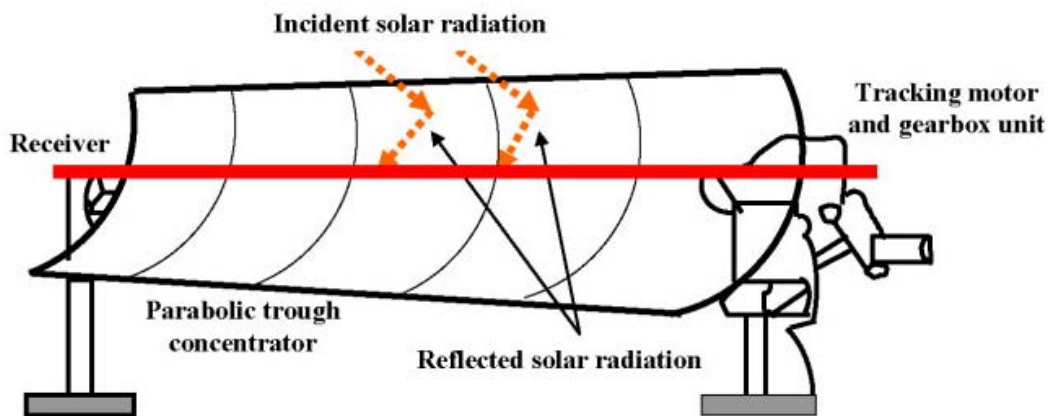

Figure 5. Parabolic trough concentrating solar collector

In a parabolic trough collector shown in Figure 5, a reflecting surface is shaped in the form of a cylindrical parabola or a trough. A receiver consisting of a tube with a concentric transparent cover is placed at the focal line of the parabola. The reflector focuses the sun's rays on to the tube (shown as dashed lines in Figure 5), where they are absorbed. A part of the absorbed energy is transferred to a heat transfer fluid flowing through it and this heat is then used to operate a thermodynamic cycle. The transparent cover around the tube reduces the convective and the radiative losses to the surroundings. In order to focus the sun's rays on to the receiver, tracking about a single axis is generally adopted. As mentioned previously, it is also possible to operate the

parabolic trough collector system with a direct steam generation configuration where the heat transfer fluid is the power cycle working fluid itself which changes phase within the tube, i.e. water getting converted into steam.

A few power plants have been installed using the direct steam generation configuration. It may be noted that the two phase flow of water and steam in the long horizontal receiver tube causes non uniform circumferential and axial cooling of the tube's surface. Besides, the outer surface of the receiver tube is subjected to non-uniform circumferential heating due to the solar radiation getting concentrated on only that side of the tube which is facing the reflector. These issues need to be tackled in power plants operating with the direct steam generation configuration. Most of the currently operating commercial parabolic trough solar thermal power plants therefore use a thermic oil as the heat transfer fluid in the collectors.

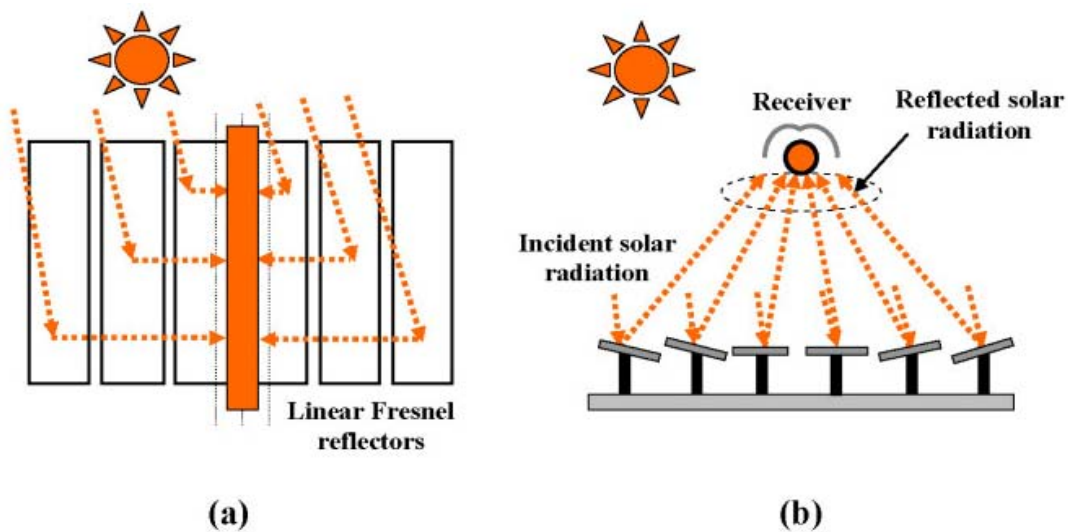

Figure 6. Linear Fresnel reflector concentrating solar collector

The linear Fresnel reflector collector shown in Figure 6 is another type of line focusing collector. The reflector consists of a number of long mirror strips (reflector rows) held side-by-side close to the ground (Figure 6a). Each mirror strip is tracked independently to reflect sun's rays (shown as dashed lines in Figure 6) to a fixed receiver which is mounted at a height of few meters above the mirrors (Figure 6b). The receiver usually consists of a compound parabolic concentrator (Figure 6b) with an absorber tube inside it. The radiation absorbed by the tube is the sum of the radiation coming directly from the reflector rows and the radiation coming after secondary reflections in the compound parabolic concentrator. The bottom of the receiver may be closed with a glass cover to minimize the convective losses to the ambient. It may be noted that the receiver could also be a trapezoidal cavity consisting of one or more tubes placed inside the cavity. Similar to a parabolic trough collector, the heat transfer fluid flowing inside the tubes of the receiver absorbs the heat and delivers the useful energy. The division of a large reflector into smaller pieces with simpler geometry is sometimes referred to as fresnelization. The efficiencies of current solar thermal power plants with linear Fresnel reflector collectors are lower than those obtained in the parabolic trough plants.

The generation of higher temperatures than those achieved in line focusing concentrating collectors is possible by using point focusing concentrating collectors. These require two axis tracking arrangements so that the sun's rays are brought to a point focus. A heat transfer fluid flowing through the receiver at the focus gets heated up and the heat is used to drive a prime mover. In case of a paraboloid dish (Figure 7), Stirling engines are typically used as the prime movers and hence the system is also referred to as the Dish-Stirling system. For the paraboloid dish systems, there are limitations on the size of the reflector area because of wind loads and requirements of a large support structure capable of two axis tracking. Consequently, these systems are used to generate power in the kilowatt range rather than in the megawatt range and hence are not suitable for large scale commercial generation of solar thermal power.

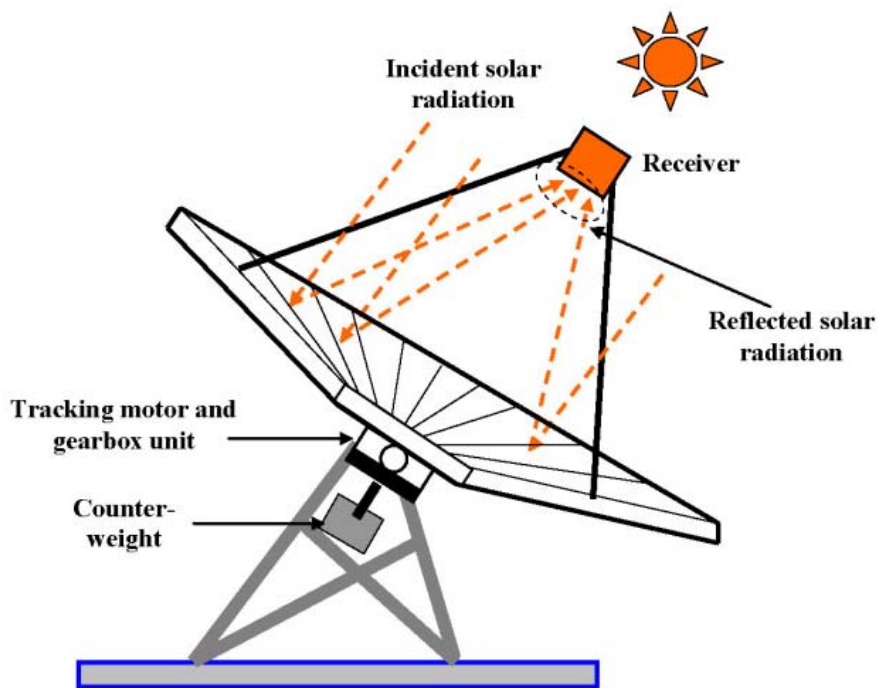

Figure 7. Paraboloid dish concentrating solar collector

In case of a central receiver system (Figure 8), the incident solar radiation is reflected from an array of reflectors (heliostats) on to a receiver mounted on the top of a tower. The heliostats are arranged on the ground around the tower and are tracked individually so that they focus beam radiation on the receiver throughout the day. A fluid passing through the receiver absorbs the heat from the concentrated radiation and is used to operate a thermodynamic cycle. The choice of the thermodynamic cycle decides the receiver-fluid combination. For example, a tubular type of receiver may be employed with molten salt as the heat transfer fluid which then transfers the thermal energy to the working fluid of the steam Rankine cycle. In another case, a combined cycle power plant may use a volumetric receiver to preheat the air entering the combustion chamber of the gas turbine.

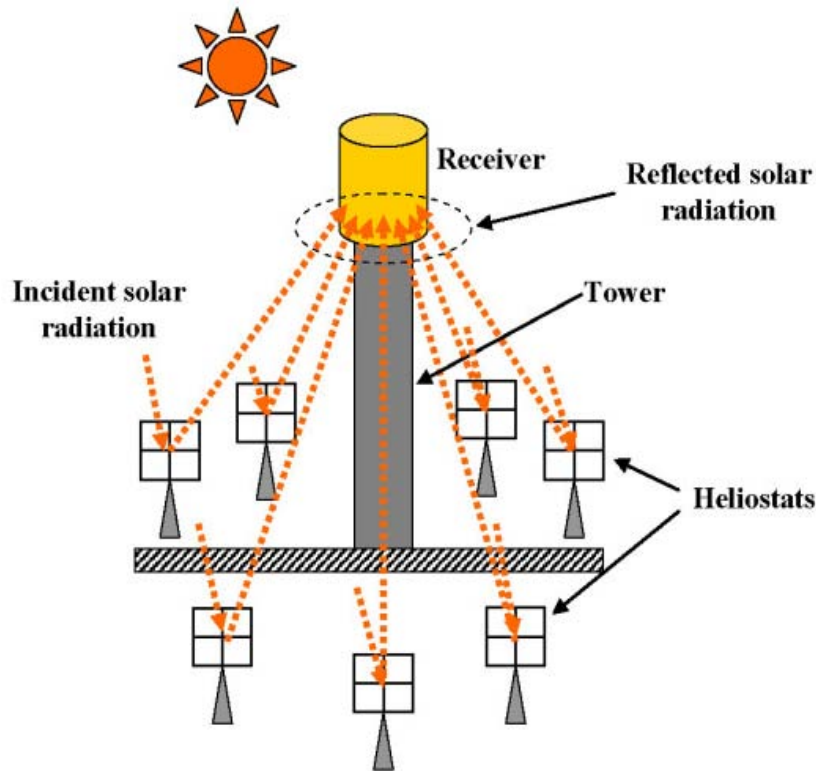

Figure 8. Central receiver or solar tower concentrating solar field

-
-
-

TO ACCESS ALL THE **31 PAGES** OF THIS CHAPTER,
Visit: <http://www.eolss.net/Eolss-sampleAllChapter.aspx>

Bibliography

Desai, N. B. (2016). Design and Optimization of Solar Thermal Power Plants. PhD thesis, Department of Energy Science and Engineering, Indian Institute of Technology Bombay, India. [This PhD thesis provides details on the modeling and optimization of solar thermal power plants with steam Rankine cycle, with organic Rankine cycle, and in a configuration with a solar field comprising of two different types of concentrators – parabolic trough and linear Fresnel reflectors.]

Duffie, J.A., Beckman W. A., and Blair N (2020). *Solar Engineering of Thermal Processes, Photovoltaics and Wind*. John Wiley & Sons Ltd., 5th edition. [This book provides information of the basics of solar radiation, solar geometry, and the analysis of various solar thermal equipment.]

Hamilton, W. T. (2019). Design and Dispatch of Concentrating Solar Power Tower Systems with Utility-Scale Photovoltaics. PhD thesis, Department of Mechanical Engineering, Colorado School of Mines, USA. [This PhD thesis presents off-design models of molten salt driven Rankine cycles and their impact on the optimal dispatch from the solar thermal power plant.]

Modi, A. (2015). Numerical Evaluation of the Kalina Cycle for Concentrating Solar Power Plants. PhD thesis, Department of Mechanical Engineering, Technical University of Denmark. [This PhD thesis provides details on the thermodynamic and thermoeconomic modeling and optimization of solar thermal power plants with high temperature Kalina cycles using ammonia-water mixture as the power cycle working fluid.]

Patnode, A. M. (2006). Simulation and Performance Evaluation of Parabolic Trough Solar Power Plants. Master thesis, Department of Mechanical Engineering, University of Wisconsin-Madison, USA. [This master thesis provides details on the detailed design and off-design modeling and simulation of parabolic trough solar thermal power plants.]

Shah, R. K. and Sekulić, D. P. (2003). *Fundamentals of Heat Exchanger Design*. John Wiley & Sons Ltd., 1st edition. [This book provides excellent information on heat exchanger design, sizing, and performance evaluation.]

Smith, R (2016). *Chemical Process – Design and Integration*. John Wiley & Sons Ltd., 2nd edition. [This book provides various cost functions for common equipment used in thermal energy systems and the chemical process industry with correction factors for pressure, temperature, and materials.]

Stine, W. B. and Geyer, M. (2001). *Power from the Sun*. Online textbook freely available at the website: <http://www.powerfromthesun.net/book.html>, last accessed on 02 December 2020. [This is an excellent online resource for basics of solar geometry and thermal and optical performance analysis of solar thermal systems.]

Spelling, J. D. (2013). Hybrid Solar Gas-Turbine Power Plants: A Thermoeconomic Analysis, PhD thesis, Department of Energy Technology, KTH Royal Institute of Technology, Sweden. [This PhD thesis provides details on the thermodynamic and thermoeconomic modeling of solar thermal power plants with gas turbines.]

Sukhatme, S. P. and Nayak, J.K (2017). *Solar Energy*. McGraw Hill Education, 4th edition. [This book provides information of the basics of solar radiation, solar geometry, and the analysis of various solar thermal equipment.]

Wagner, M. J. (2008). Simulation and Predictive Performance Modeling of Utility-Scale Central Receiver System Power Plants. Master thesis, Department of Mechanical Engineering, University of Wisconsin-Madison, USA. [This master thesis presents the solar thermal power plant models and their performance evaluation using TRNSYS software.]

Biographical Sketches

Jayanta Kumar Nayak is Professor Emeritus, Department of Energy Science and Engineering at the Indian Institute of Technology Bombay, India. He has been a faculty member at the institute since 1982. Prior to that he received his PhD from Indian Institute of Technology Delhi and served as a project staff at the Centre for Energy Studies there. He is known for his contributions to teaching and research in the field of thermal applications of solar energy. He is the co-author of *Solar Energy and Handbook on Energy Conscious Buildings*.

Anish Modi is an Assistant Professor at the Department of Energy Science and Engineering at the Indian Institute of Technology Bombay, India and has previously worked at the Technical University of Denmark (DTU) and Alstom Projects India Limited (now GE Power). He received his MSc from the Royal Institute of Technology (KTH), Sweden and Polytechnic University of Catalonia (UPC), Spain and his PhD from DTU, Denmark. His research interests include thermal energy systems, solar thermal energy, concentrating solar power, polygeneration, and energy sustainability.